

Varenummer: 0125084
 Beskrivelse: Seeger låsering SP75
 Fjederstål

Mål

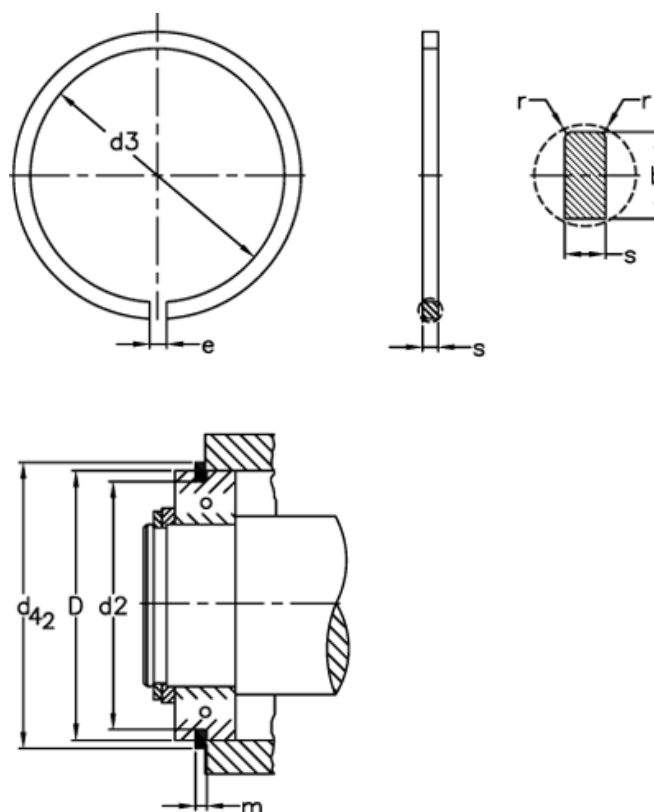

b	= 4.85	FRg kN	= 6.46	tol	= -0.15
Betegnelse	= SP 75	FR kN	= 36.6	tol	= -0.1
D	= 75	g	= 2.5	tol	= -0.50
d2	= 71.83	K kN-mm	= 68.6	tol	= 0.3
d3	= 70.4	m	= 1.90	tol	= 0.8
d42	= 81.6	n abl x 1000	= 3.0	vægt kg/1000	= 15.3
e	= 5	r min	= 0.6		
FN kN	= 61.5	s	= 1.70		